



# CDPS-44SM

HDMI 4x4 Seamless Matrix Switcher



Operation Manual



## DISCLAIMERS

The information in this manual has been carefully checked and is believed to be accurate. Cypress Technology assumes no responsibility for any infringements of patents or other rights of third parties which may result from its use.

Cypress Technology assumes no responsibility for any inaccuracies that may be contained in this document. Cypress also makes no commitment to update or to keep current the information contained in this document.

Cypress Technology reserves the right to make improvements to this document and/or product at any time and without notice.

## COPYRIGHT NOTICE

No part of this document may be reproduced, transmitted, transcribed, stored in a retrieval system, or any of its part translated into any language or computer file, in any form or by any means—electronic, mechanical, magnetic, optical, chemical, manual, or otherwise—without express written permission and consent from Cypress Technology.

© Copyright 2012 by Cypress Technology.

All Rights Reserved.

Version 1.0 January 2012

## TRADEMARK ACKNOWLEDGMENTS

All products or service names mentioned in this document may be trademarks of the companies with which they are associated.





## SAFETY PRECAUTIONS

Please read all instructions before attempting to unpack, install or operate this equipment and before connecting the power supply.

Please keep the following in mind as you unpack and install this equipment:

- Always follow basic safety precautions to reduce the risk of fire, electrical shock and injury to persons.
- To prevent fire or shock hazard, do not expose the unit to rain, moisture or install this product near water.
- Never spill liquid of any kind on or into this product.
- Never push an object of any kind into this product through any openings or empty slots in the unit, as you may damage parts inside the unit.
- Do not attach the power supply cabling to building surfaces.
- Use only the supplied power supply unit (PSU). Do not use the PSU if it is damaged.
- Do not allow anything to rest on the power cabling or allow any weight to be placed upon it or any person walk on it.
- To protect the unit from overheating, do not block any vents or openings in the unit housing that provide ventilation and allow for sufficient space for air to circulate around the unit.

## REVISION HISTORY

VERSION NO.	DATE DD/MM/YY	SUMMARY OF CHANGE
RDV1	21/09/13	Preliminary Release
RDV2	17/04/13	
RDV3	04/06/13	Matrix mode 1080i@50/60 IN4 Disabled
RDV4	18/11/13	Add WebGUI
RDV5	06/01/14	Add notes on 1080i@50/60 timing
RDV6	10/02/15	Add Dual PiP& Quad Function

---

## CONTENTS

<b>1. Introduction</b> .....	<b>1</b>
<b>2. Applications</b> .....	<b>1</b>
<b>3. Package Contents</b> .....	<b>1</b>
<b>4. System Requirements</b> .....	<b>1</b>
<b>5. Features</b> .....	<b>2</b>
<b>6. Operation Controls and Functions</b> .....	<b>3</b>
6.1 Front Panel .....	3
6.2 Rear Panel.....	7
6.3 Remote Control.....	8
6.3.1 Remote Control Dip Switch.....	9
6.4 RS-232 Protocols .....	10
6.5 RS-232 & Telnet Commands.....	10
6.6 RS-232 & Telnet control .....	14
6.7 Telnet Setting .....	15
6.8 OSD MENU.....	16
6.9 Web GUI .....	22
<b>7. Connection Diagram</b> .....	<b>24</b>
<b>8. Specifications</b> .....	<b>25</b>
<b>9. Timing</b> .....	<b>25</b>
9.1 Input Support Timing .....	25
9.2 Output Support Timing .....	26





## 1. INTRODUCTION

The 4 by 4 HDMI Seamless Matrix Switcher allows the signal from 4 different input sources to be freely selected and arranged on 4 displays (TV or monitor), providing four output modes (Matrix, Dual PoP/ PiP, Quad and TV Wall) for various applications. Matrix mode routes the source signals to output displays as regular matrix does, Dual mode allows 2 sets of 2 selected sources to show on designate output displays with PoP and PiP method and TV Wall mode extends a selected source to display on all 4 output displays as one. The device supports video timings up to WUXGA@60RB and 1080p@60Hz, audio format up to 7.1CH LPCM at 192kHz sampling rate based on input source EDID. For all the operation/control can be done through IR, remote control, Telnet, WebGUI, RS-232 or front panel buttons.

## 2. APPLICATIONS

- Broadcasting room and control
- Surveillance room and control
- Public advertisement and control
- Digital Presentation
- Conference call or meeting room presentation

## 3. PACKAGE CONTENTS

- 1 x 4 by 4 Seamless Matrix Switcher
- 1 x Remote Control (CR-125)
- Software CD Driver (Optional)
- 1 x 12V/3A DC Power Adaptor
- Operation Manual

## 4. SYSTEM REQUIREMENTS

Input source equipments such as DVD/Blu-ray players or any video signal and PC/Notebook devices and output HD TV/monitor.

## 5. FEATURES

- HDMI, HDCP1.1 and DVI compliant
- Deep color support 8/10/12 bit source
- Seamless switching
- Supports four different modes: Matrix mode/ Dual mode/ Quad / TV Wall mode
  - Matrix mode: Can routes and output any 4 source to any 4 displays with seamless switching  
**Note:** *Under output timing 1080i@50/60 input 4 will be disabled, OSD will show "IN 4 Disabled"*
  - Dual mode: Can display POP (Picture Of Picture) & PiP (Picture In Picture) image combined by 2 sources to be presented on the HDMI output ports (Dual A and Dual B)
  - Quad mode: Can output all sources to a display (4 in 1) as a full image.
  - TV Wall mode: Can output any source to 4 displays (2 by 2 Video wall) as a full image with adjustable Bezel Correction for 4 displays
- Supports OSD, RS232, Telnet, WebGUI, Remote control and on-panel controls
- Input resolutions support VGA~WUXGA and 480i~1080p
- Output resolutions support 480p~1080p
- Supports different input resolution and output resolution selectable from OSD menu. The factory default value for the output resolution is 720p@60Hz/ 2CH LPCM
- Audio supports LPCM 2CH, 6CH, 8CH/AC3/DTS/Dolby Digital Plus/ Dolby TruHD & DTS-HD

## 6. OPERATION CONTROLS AND FUNCTIONS

### 6.1 Front Panel

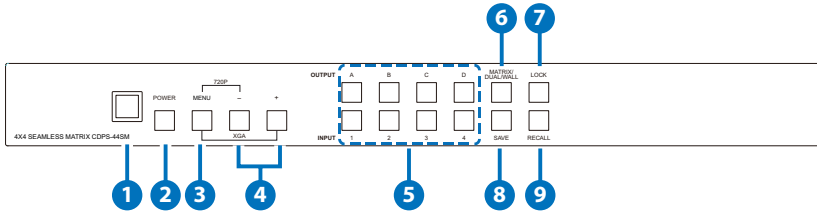

#### 1 IR Window:

Accept IR signal from the device's remote control included in the package.

#### 2 Power

- ON/OFF: Press this button to power on the device or set it to standby mode.
- Factory default: Press Power then connect power supply to reset the system to Factory default setting.

#### 3 MENU:

Press this button to bring up the OSD menu on screen.

Press "MENU" with "-" button to switch output timing to 720P@60Hz instantly.

Press "MENU" with "+" button to switch output timing to XGA (1024x768@60Hz) instantly.

#### 4 -/+ Buttons:

Press these buttons to scroll down/up the OSD selections then press "MENU" button to confirm.

#### 5 CHANNEL INPUT 1~4 and CHANNEL OUTPUT A~D:

- Matrix mode: To display any of the four sources on to any of the four displays.
  - i. Press "Matrix/Dual/TV Wall" button to switch to Matrix mode and LED will illuminate constantly.
  - ii. Press an output from A~D and then press corresponding input from 1~4. For example: press output A then press input 1, output A will display input 1's image. Each output setting must



be made individually.

- Dual PoP mode: To combine 2 sources to be presented on each HDMI output ports (Dual A and Dual B) as left and right image.
  - i. Press "Matrix/Dual/TV Wall" button to switch to Dual PoP mode and LED unilluminate.
  - ii. Press output A/B and then press corresponding input 1/2. For example: press output A then press input 1, output A will display input 1's image on the left side, then press output B and then press input 2, output A will display input 2's image on the right side. Both output A and B will have identical image.
  - iii. Dual A group are output A and B, Dual B group are output C and D. Each group will output the same image simultaneously.
  - iv. Press button A or B for 3 seconds, to switch Dual A channel's audio between output A or B.
  - v. Press button C or D for 3 seconds, to switch Dual B channel's audio between output C or D.
- TV Wall mode: To display a source signal on to four displays as a big screen.
  - i. Press "Matrix/Dual/Wall" button to switch to TV Wall mode and LED will blink once.
  - ii. Press input 1~4 to select a source to 4 displays (2 by 2 Video wall). The audio will be on output A only.

#### PoP/PIP Mode Function Buttons

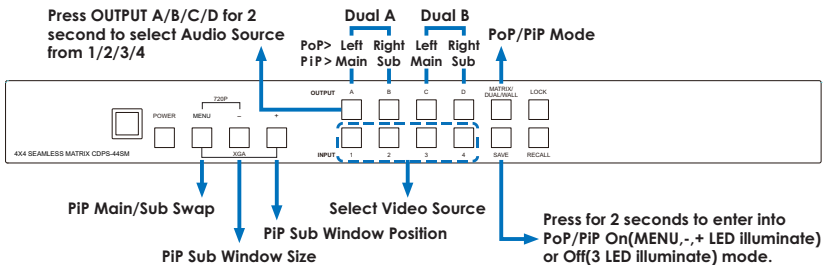



- Dual PiP mode: To combine 2 sources to be presented on each HDMI output port (Dual A and Dual B) as main and sub screen image. The sub screen is in a part of the main screen.
  - i. Press "Matrix/Dual/TV Wall" button to switch to Dual PiP mode and LED will blink twice.
  - ii. Press output A/B and then press corresponding input 1/2. For example: press output A then press input 1, output A will display input 1's image as a main screen, then press output B and then press input 2, output A will display input 2's image as a sub screen. Both output A and B will have identical image.
  - iii. Dual A group are output A and B, Dual B group are output C and D. Each group will output the same image simultaneously.
  - iv. Press button A or B for 3 seconds, to switch Dual A channel's audio between output A or B.
  - v. Press button C or D for 3 seconds, to switch Dual B channel's audio between output C or D.
  - vi. Press "SAVE" button for 2 seconds to enter into Dual mode operation and both "MENU" and "-" & "+" buttons will illuminate.  
  
Press "MENU" to swap in between the Dual PiP's main and sub image position, press the "-" to adjust the sub screen size to small/medium/large and press the "+" to select sub screen's position from top left/right to bottom left/right. Press "SAVE" button for 2 seconds to switch back to previous mode and both "MENU" and "-" & "+" buttons will unilluminated.
- Quad mode: To combine 4 sources' to be presented on each HDMI output port as a full image, all outputs display identical image and the LED will blink three times.
  - i. Press A~D to select Quad 1~4 and press 1~4 to select input sources.
  - ii. Press A~D for 2 second to select the audio input, only one audio can be selected each time under Quad mode.

## **6 MATRIX/DUAL/TV WALL:**

Press to switch between Matrix mode, Dual mode, TV Wall and Quad mode. When in Matrix mode the LED will illuminate constantly, when in DUAL PoP mode the LED will unilluminate, when in TV Wall mode the LED will blink once, when in Dual PiP mode the LED will blink twice and in Quad mode the LED will blink three times.

## **7 LOCK:**

Press once to lock the keypad and remote control, press 3 second again to release the lock function.

## **8 SAVE:**

To save the customized input and output corresponding settings.

- Press "Matrix/Dual/Wall" button to select mode status.
- Press each output channel A~D and then press corresponding input channel 1~4.
- Press "SAVE", the input 1~4 LEDs will all illuminate at the same time, then press input 1/2/3 or 4 to save to the system memory.

For example: Select Matrix mode, press output A then press input 4, then press "SAVE". This will corresponding to remote control FAV.1~FAV.4.

## **9 RECALL:**

When in the mode status "Matrix, Dual or Wall", press "RECALL" and the input channel 1~4 LED will illuminate at the same time, and select input channel 1/2/3 or 4 to recall the customized screen settings and this will corresponding to remote control FAV.1~FAV.4.

## 6.2 Rear Panel

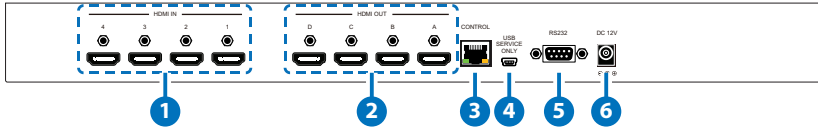

### 1 HDMI IN 1~4:

Connect with HDMI source equipments such as DVD/Blue-ray players and or PC/Notebook devices.

### 2 HDMI OUT 1~4:

Connect with HDMI TV/Monitor/Recorder for output image display or saving.

### 3 Control:

Connect to an active network for telnet control (Please refer to 6.5 telnet Commands).

### 4 USB SERVICE ONLY:

This slot is reserved for factory use only.

### 5 RS-232:

Connect from PC/Notebook with D-Sub 15pin cables for RS-232 command sending and controlling over the device.

### 6 DC 12V:

Plug the 12V DC power supply into the unit and connect the adaptor to an AC outlet.

## 6.3 Remote Control

- 1 **Power:** Press this button to switch on the device or press it again to set it to standby mode.
- 2 **Info:** Press this button to show the device's firmware version.
- 3 **Out A~D and In 1~4:** Press output A~D and then press input 1~4 to select display input. For example: press Out A then press In 1, output A will display input 1's image.
- 4 **MATRIX/DUAL/WALL:** Press to switch between Matrix mode, Dual mode and TV Wall mode. Press the DUAL button to switch between PoP and PiP mode.

**Note:** Quad mode selection is not supported from this remote control.

- 4.5 **PiP Mode:** Under PiP mode, press OUT A/B to select PiP A and press OUT C/D to select PiP B.

Press "up & down" keys to change size and "left & right" keys to change position.

Press OK key to swap Main/Sub image.

- 5 **Lock:** Press once to lock the keypad and remote control, press 3 second again to release the lock function.
- 6 **Mute:** Press this button to mute the audio from HDMI output port.
- 7 **▲/▼/←/→/OK:** Press these buttons to scroll through the OSD selection and press OK to enter and confirm the setting.
- 8 **Exit:** Press this button to exit the OSD menu or the OSD settings.
- 9 **Menu:** Press this button to enter into the OSD menu.

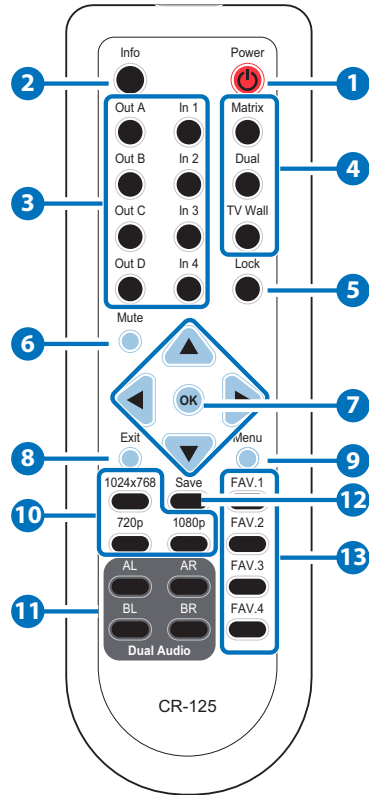



- 10 **1024x768/720p/1080p:** Press these hot keys to switch between each resolution for outputs.
- 11 **AL/AR/BL/BR:** When in Dual & Quad mode, press these hot keys to switch the audio channel in Left or Right side for Dual A and Dual B group.
- 12 **SAVE:** To save the customized input and output corresponding settings.
  - Press "Matrix/Dual/Wall" button to select mode status.
  - Press each output channel A~D and then press corresponding input channel 1~4.
  - Press "SAVE", then input 1~4's LED will illuminate at the same time, then press remote control FAV.1~FAV.4 to save to the system memory.
- 13 **FAV.1~FAV.4:**

Press favorite hot keys 1~4 to bring up the customized screen save settings.

### 6.3.1 Remote Control Dip Switch

Open Remote control back cover to adjust dip-switch ON/OFF to match IR address setting in the OSD menu. Factory default is on 0.

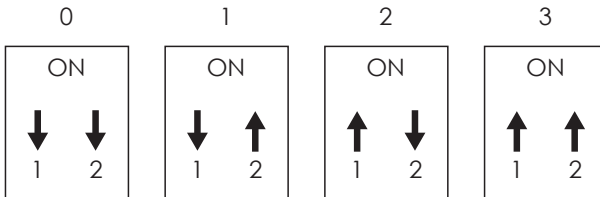

## 6.4 RS-232 Protocols

CDPS-44SM			Remote Controller(PC)	
PIN	Assignment		PIN	Definition
1	NC		1	NC
2	TxD		2	RxD
3	RxD	▶	3	TxD
4	NC	◀	4	NC
5	GND		5	GND
6	NC		6	NC
7	NC		7	NC
8	NC		8	NC
9	NC		9	NC

Baud Rate: 115200bps

Data Bit: 8 bits

Parity: None

Flow Control: None

Stop Bit: 1

## 6.5 RS-232 & Telnet Commands

All commands will be not executed unless followed with a carriage return (0x0D) and commands are case-sensitive.

Command	Active	CDPS-44SM Return
ASP000	Aspect Ratio is Full	ASP000
ASP001	Aspect Ratio is 4:3 TV	ASP001
ASP002	Aspect Ratio is 16:9 TV	ASP002
ASP003	Aspect Ratio is 16:10 TV	ASP003
ASP004	Aspect Ratio is to Keep Ratio	ASP004
ASP999	Check Aspect Ratio status	ASP???
AUA001	Dual A Audio channel in Left/Main side	AUA001
AUA002	Dual A Audio channel in Right/Sub side	AUA002
AUA999	Check Dual A audio channel status	AUA???
AUB001	Dual B Audio channel in Left/Main side	AUB001
AUB002	Dual B Audio channel in Right/Sub side	AUB002
AUB999	Check Dual B audio channel status	AUB???
AUD000	Audio output Off	AUD000

Command	Active	CDPS-44SM Return
AUD001	Audio output On	AUD001
AUD999	Check audio on/off status	AUD???
AUE000	Audio edid is LPCM 2CH	AUE000
AUE001	Audio edid is LPCM 6CH	AUE001
AUE002	Audio edid is LPCM 8CH	AUE002
AUE003	Audio edid is BITSTREAM	AUE003
AUE004	Audio edid is HD	AUE004
AUE999	Check audio edid setting	AUE???
AUQ001	Quad Audio from Quad 1	AUQ001
AUQ002	Quad Audio from Quad 2	AUQ002
AUQ003	Quad Audio from Quad 3	AUQ003
AUQ004	Quad Audio from Quad 4	AUQ004
AUQ999	Check Quad audio setting	AUQ???
BEZ000	Bezel Correction OFF	BEZ000
BEZ001	Bezel Correction ON	BEZ001
BEZ999	Check bezel correction on/off status	BEZ???
BEH???	Horizontal (H) Bezel correction???=000 ~ Maximum	BEH???
BEH998	Check the current Horizontal(H) Bezel correction Maximum value	BEH???
BEH999	Check the current Horizontal(H) Bezel correction setting value	BEH???
BEV???	Vertical (V) Bezel correction???=000 ~ Maximum	BEV???
BEV998	Check the current Vertical(V) Bezel correction Maximum value	BEV???
BEV999	Check the current Vertical(V) Bezel correction setting value	BEV???
BRI???	Setting Brightness ???=000~100 for matrix mode	No response
	???=(000~100)+200*(OUT No.-1) for dual/tv wall/quad mode	
	For example: OUT B set the Brightness value to 57 =(57)+200*(2-1) = 257	
BRI99?	Check current Brightness value 99?=999 for matrix mode 99?=991~994=OUT1~4 for dual/tv wall/quad mode	BRI???
CAL???	RECALL FAV. ???=001~004=FAV.1~4	CAL???
CON???	Setting Contrast	No response
CON999	Command setting same as Brightness(BRI)	CON???
DUL001	Set Dual mode to PoP	DUL001
DUL002	Set Dual mode to PIP	DUL002



Command	Active	CDPS-44SM Return
DUL003	Check Dual mode status	DUL999
EGW999	RS232 only, check current Ethernet Gateway Address	aaa.bbb.ccc. ddd
EIP999	RS232 only, check current Ethernet IP Address	aaa.bbb.ccc. ddd
EMK999	RS232 only, check current Ethernet Subnet Mask Address	aaa.bbb.ccc. ddd
HLP999	Show Command List	Command List
HPI0xy	HDCP Input setting x=1~4=IN 1~4, y=o=On, y=1=Off	HPI0xy
HPI99?	Check HDCP INPUT setting ?=1~4 =IN1~4	HPI0xy
HPO0xy	HDCP Output setting x=1~4=OUT A~D, y=o=Follow Input, y=1=Follow Output	HPI0xy
HPO99?	Check HDCPOUTPUT setting ?=1~4 =OUT A~D	HPO0xy
HUE???	Setting HUE	No response
HUE999	Command setting same as Brightness (BRI)	HUE???
INP???	INPUT selection????=001~004=IN 1~4 Execute OUT???	INP???
INP999	Check current INPUT	INP???
LAB000	Set Input Label Off	LAB000
LAB001	Set Input Label On	LAB001
LAB99x	Check current Input Label On/Off	LAB???
LAlxyyyyyy	Set Input Label Name x=1~4=In 1~4, yyyyyyyyyyy max. 12 Character	LAlxyy...
LAI99?	Check input Label Character ?=1~4 =IN 1~4	LAlxyy...
LCK000	Un-lock	LCK000
LCK001	Lock	LCK001
LCK999	Check current Lock/un-lock status	LCK???
MNE001	OSD Menu EXIT	No response
MND001	OSD Menu DOWN	No response
MNL001	OSD Menu LEFT (-)	No response
MNO001	OSD Menu OK	No response
MNR001	OSD Menu RIGHT (+)	No response
MNU001	OSD Menu UP	No response
MNX001	OSD Menu	No response

Command	Active	CDPS-44SM Return
MOD001	Matrix mode	MOD001
MOD002	Dual PoP mode	MOD002
MOD003	TV Wall mode	MOD003
MOD004	Dual PiP mode	MOD004
MOD005	Quad Mode	MOD005
MOD999	Check current output mode status	MOD???
OUT???	OUTPUT selection???=001~004=OUT A~D	OUT???
OUT999	Check current OUTPUT	OUT???
PPO0xy	Dual PiP/Sub Position x=1~2=PiP A~B y=0=Upper left, 1=Upper right, 2=Lower right, 3= Lower left	PPO0xy
PPO99?	Check PiP/Sub Postion status ?=1~2=PiP A~B	PPO0xy
PSW001	Dual PiP A(Main) image swap with Sub	PSW001
PSW002	Dual PiP B(Sub) image swap with Main	PSW002
PSZ0xy	Dual PiP/Sub Size x=1~2=PiP A~B y=0=Large, 1=Medium, 2=Small, 3= Off	PSZ0xy
PSZ99?	Check PiP/Sub Size status ?=1~2=PiP A~B	PSZ0xy
PWR000	Power Off(Standby)	PWR000
PWR001	Power On	PWR001
PWR999	Check current power status	PWR???
RES???	Output resolution???=001~ ...corresponding osd menu list	RES???
RES999	Check current output resolution	RES???
RST001	Factory Reset	RST001
RST002	Picture Reset	RST002
SAT???	Setting Saturation	No response
SAT999	Command setting same as Brightness (BRI)	SAT???
SAV???	SAVE FAV. ???=001~004=FAV.1~4	SAV???
VER999	Check firmware version	VER???
		Example: VER110=V1.1
VR2999	Check customer's firmware version	VR2???

## 6.6 RS-232 & Telnet control

Using PC software or Hyper terminal to configure the setting. This software application can be downloaded from the product website.

Simply control panel:

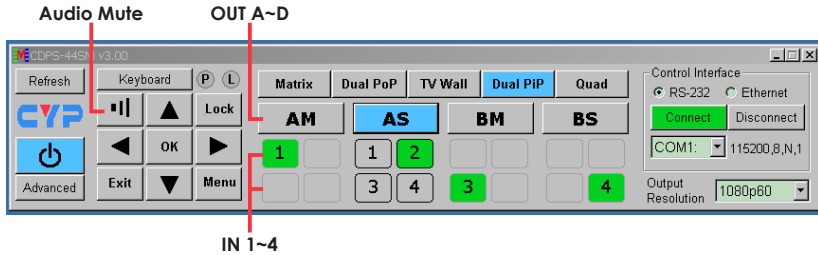

Full function control panel:

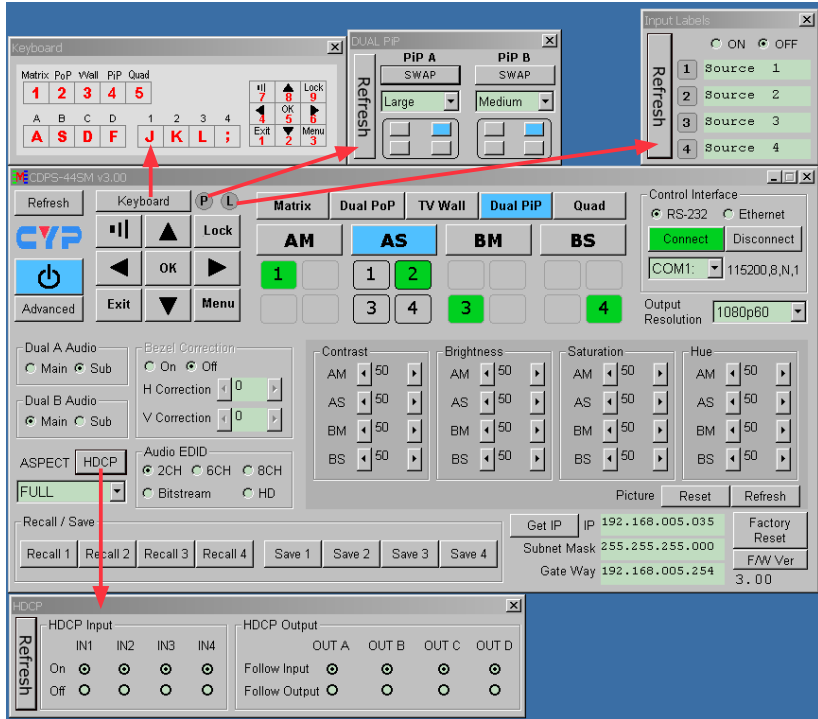

## 6.7 Telnet Setting

Through TCP/IP protocol, to sent Port 23 for Telnet communication.  
From OSD menu or through RS-232 command to check Telnet connection behavior.



```
Telnet 192.168.5.155

ASP = Aspect Ratio
AUA = Dual A Audio
AUB = Dual B Audio
AUD = Audio Out On/Off
AUE = Audio EDID
AUQ = Quad Audio
BEZ = Bezel On/Off
BEH = Bezel Hori.
BEU = Bezel Vert.
BRI = Brightness
CAL = Recall FAU.
CON = Contrast
DUL = Dual Mode
ERR = Error Command
ETH = Telnet Status
EIP = Ethernet IP
EMK = Ethernet Submask
EGW = Ethernet Gateway
EXT = Don't Care
FWU = F/W Sub Version
HLP = Help Message
HPI = HDCP Input
HPO = HDCP Output
HUE = HUE
INF = OSD INFO. On/Off
INP = Input Select
LAB = Lable On/Off
LAI = Label Input
LCK = Panel Lock
MNE = Menu Exit
MND = Menu Down
MNL = Menu Left
MNO = Menu Ok
MNR = Menu Right
MNU = Menu Up
MNX = Menu On
MOD = Output Mode
OUT = Output Select
PPO = PiP Position
PSW = PiP Swap
PSZ = PiP Size
PWR = Power On/Off
RES = Output Resolution
RST = Fact./Pic. Reset
SAT = Saturation
SAU = Save FAU.
TST = Test
UER = F/W Main Version
UR2 = F/W Custom Version
```

## 6.8 OSD MENU

Main Menu	Sub Menu	Adjustments	Default
MODE	MATRIX		MATRIX
	DUAL PoP		
	TV WALL		
	DUAL PiP		
	QUAD		
	EXIT		

Main Menu		Sub Menu	Adjustments	Default	
PICTURE (*1)	ALL	CONTRAST	0 ~ 100	50	
		BRIGHTNESS	0 ~ 100	50	
		SATURATION	0 ~ 100	50	
		HUE	0 ~ 100	50	
	DUAL PoP	PoP A LEFT			
		PoP A RIGHT			
		PoP B LEFT			
		PoP B RIGHT			
	TV WALL	OUT A			
		OUT B			
		OUT C			
		OUT D			
	DUAL PiP	PiP A MAIN			
		PiP A SUB			
		PiP B MAIN			
		PiP B SUB			
	QUAD	OUT 1			
		OUT 2			
		OUT 3			
		OUT 4			
	DUAL/TV WALL/QUAD	RESET			
	ALL MODE	RESET ALL			
		EXIT			

Main Menu	Sub Menu	Adjustments	Default
OUTPUT RESOLUTION	480p, 576p, 720p50, 720p60, 1080i50(*2), 1080i60, 1080p24, 1080p50, 1080p60, 1024x768, 1280x800, 1280x1024, 1366x768, 1440x900, 1600x900, 1600x1200, 1680x1050, 1920x1200		720p60
	EXIT		
AUDIO EDID (*3)	LPCM 2CH, LPCM 6CH,		LPCM 2CH
	LPCM 8CH, BIT-STREAM, HD EXIT		
OSD SETTINGS	POSITION	LEFT T, RIGHT T, LEFT B, RIGHT B	LEFT T
	H OFFSET	0 ~ 20	10
	V OFFSET	0 ~ 20	10
	TV WALL OSD	1 Output, 4 Outputs	4 Outputs
	TRANSPARENCY	0 ~ 9	4
	MENU TIMEOUT	5 ~ 50, OFF(*4)	8
	INFO.TIMEOUT	5 ~ 50, OFF	8
	INFO.DISPLAY	ON, OFF	ON
	BRIEF INFO	ON, OFF	OFF
EXIT			

Main Menu	Sub Menu	Adjustments	Default
HDCP	INPUT 1(*5)	ON, OFF	ON
	INPUT 2	ON, OFF	ON
	INPUT 3	ON, OFF	ON
	INPUT 4	ON, OFF	ON
	OUTPUT A~D(*6)	FOLLOW INPUT, FOLLOW OUT- PUT	FOLLOW INPUT
	EXIT		
BEZEL CORRECTION (*7)	CORRECTION	ON, OFF	OFF
	H CORRECTION	0 ~ by output resolution	0
	V CORRECTION	0 ~ by output resolution	0
	EXIT		
RECALL / SAVE (*8)	RECALL	CANCEL, FAV.1 ~ 4	CANCEL
	SAVE	CANCEL, FAV.1 ~ 4	CANCEL
	EXIT		
ETHERNET	IP MODE	DHCP, STATIC	DHCP
	STATIC SET	IP, MASK, GATE	IP
	BYTE1		192
	BYTE2		168
	BYTE3		5
	BYTE4		155
	RE-LINK(*9)		
	TIMEOUT (Min.)(*10)	5~60, OFF	10
OTHERS	ASPECT RATIO(*11)	FULL, 4:3TV, 16:9 TV, KEEP Ratio	FULL
	INPUT LABELS(*12)	ON, OFF	OFF



Main Menu	Sub Menu	Adjustments	Default
OTHERS	IR ADDRESS(*13)	0 ~ 3	0
	EXIT		
FACTORY DEFAULT	YES, NO		NO
EXIT	EXIT		
INFORMATION (*14)	IN/OUT RESOLUTION, SOURCE HDCP/AU- DIO, OUT A NATIVE, OUT MODE, FIRM- WARE VER		
	EXIT		
EXIT			

**Note:**

**\*1 Picture:**

*In Matrix mode, four pictures adjust simultaneously.*

*In Dual/TV Wall/Quad mode, each picture can adjust individual and support individual last memory feature.*

**\*2 Output:**

*The 1080i@50 and 1080i@60 output resolutions are supported in 'Matrix' mode only. When these output resolutions are used, Input Port 4 will not function and will not be selectable in the OSD Menu. In 'Dual' or 'TV Wall' modes these output resolutions are unavailable and can not be selected in the OSD menu.*

**\*3 AUDIO EDID:**

*Embedded input audio EDID contents,*

*LPCM 2CH = LPCM 2CH*

*LPCM 6CH = LPCM 2CH/ 6CH*

*LPCM 8CH = LPCM 2HC/ 6CH/ 8CH*

*BITSTREAM = LPCM 2CH, AC3, DTS*

*HD = LPCM 2CH/ 6CH/ 8CH, AC3, DTS, Dolby Digital Plus, DTS-HD*

**\*4 TIMEOUT =OFF means MENU and INFO will continue showing on the screen**

**\*5 HDCP INPUT:**

*ON: Support HDCP source, this is normal source setting*

*OFF: Not support HDCP source. For example: Apply source.*

**\*6 HDCP OUTPUT:**

*FOLLOW INPUT:* If source with HDCP the output will support HDCP. If input source without HDCP the output will display blue screen. When in Dual mode, one of each side (Left or Right) support HDCP, the output will support HDCP.

*FOLLOW OUTPUT:* All the TV/Monitor need to support HDCP, to avoid switching source from non-HDCP to HDCP, the flashing image or no image.

**\*7 BEZEL CORRECTION:**

Only support in TV Wall mode, after adjustment the system will support last memory function. Output 480p & 576p resolution are not supported.

**\*8 SAVE/RECALL:**

To SAVE/RECALL input/output setting, the system support last memory function to save all the setting and all mode also has independent last memory function.

**\*9 Ethernet RE-LINK:**

After the setup, need to RE-LINK the system and re-connect the system again.

**\*9 Ethernet TIMEOUT:**

Select OFF to end the time out function or when telnet is under idol without sending commands within the time out setting the telnet system will be terminated.

**\*10 IR ADDRESS:**

This setting is to match the IR remote control dip switch. Please referred to 6.31.

**\*11 ASPECT RATIO:**

- Manual setting: 4:3, 16:9 & 16:10 rotating according to display's size.
- Keep Ratio: Read output A's EDID and refers to its first detail timing to set aspect ratio automatically.
- Matrix/Dual/TV Wall/Quad mode has its own independent last memory setting.

**\*12 INPUT LABELS:**

To show Input/Output name, rename system can be done under RS-232/Telnet/WebGUI with max. 12 characters. Default naming are Source 1~4.

**\*13 IR ADDRESS:**

To select IR Remote dip switch setting from 0~3.

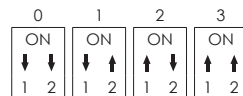

The IR remote address can be set using the two DIP switches in the back of the remote, inside the battery cover.

**\*14 INFORMATION:**

To show Input/Output/Audio/Mode/Firmware information.

## 6.9 Web GUI

Connect the device's CONTROL port from an active network service with RJ-45 terminated CAT5e/6 cable and open a web browser from a PC/laptop with device's IP address on the web address entry bar then hit enter. The browser will display device's Routing, Output, OSD and System setting pages.

**Note:** Power Status must set to ON and Source status must be unlock in in order to set the setting accordingly.

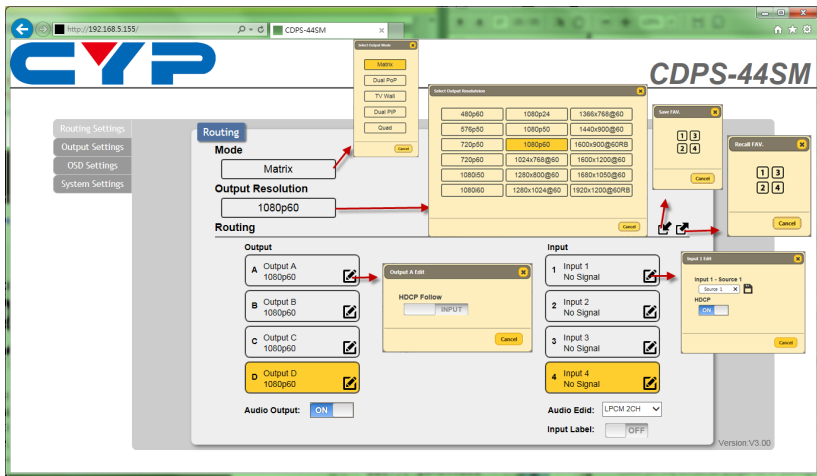

Click, drag, select or key-in on each selection setting to make the changes immediately.

Click on the System Setting for IP configuration setting. Both the device (from the OSD setting menu) and the web address entry bar will need to be reset once any change is made on this page.

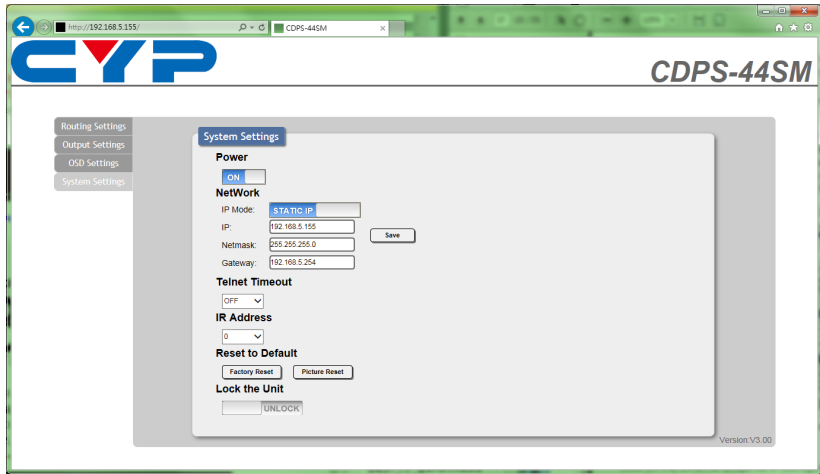

## 7. CONNECTION DIAGRAM

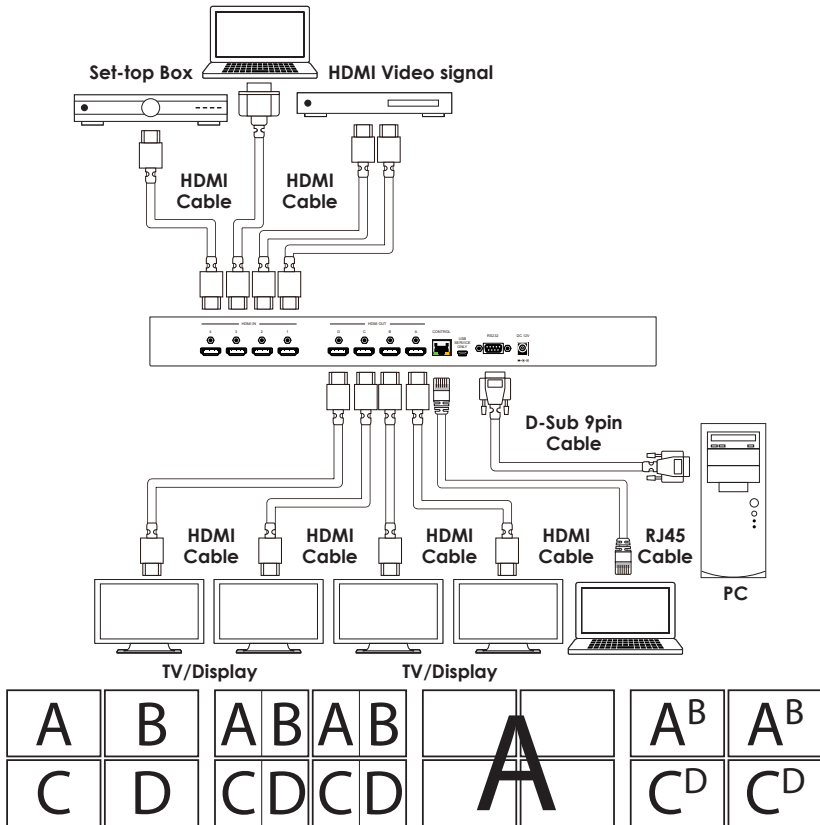



## 8. SPECIFICATIONS

<b>Video Bandwidth</b>	225MHz/6.75Gbps
<b>Input port</b>	4x HDMI (Female type) 1xUSB (Service only)
<b>Output port</b>	4 x HDMI (Female type)
<b>Power Supply</b>	12V/3A DC (US/EU standards, CE/FCC/UL certified)
<b>ESD Protection</b>	Human body model: ±8kV (air-gap discharge) ±4kV (contact discharge)
<b>Dimensions (mm)</b>	436(W) x 247(D) x 44(H)
<b>Weight(g)</b>	2200
<b>Chassis Material</b>	Aluminum
<b>Silkscreen Color</b>	Black
<b>Operating Temperature</b>	0°C ~ 40°C / 32 °F ~ 104 °F
<b>Storage Temperature</b>	-20°C ~ 60°C / -4 °F ~ 140 °F
<b>Relative Humidity</b>	20 ~ 90% RH (non-condensing)
<b>Power Consumption</b>	15w

## 9. TIMING

### 9.1 Input Support Timing

Support Timing
480i@59
480p@60
576i@50
576p@50
720p@25,30,50,60,
1080i@50,60
1080p@24,25,30,50,60
640x480@60,72,75,85
720x400@70
800x600@56,60,72,75,85
1024x768@60,70,75,85
1152x864@70,75
1280x720@60cvt
1280x768@60RB,60,75
1280x800@60RB,60,75

1280x1024@60,60cvt,75
1360x768@60
1366x768@60RB,60
1400x1050@60RB,60
1440x900@60RB,60,75
1600x900@60RB
1600x1200@60
1680x1050@60RB,60
1920x1200@60RB

## 9.2 Output Support Timing

Support Timing	
480p60	1024x768@60
576p50	1280x800@60
720p50	1280x1024@60
720p60	1366x768@60
1080i50 (Matrix Mode Only)	1440x900@60
1080i60 (Matrix Mode Only)	1600x900@60RB
1080p24	1600x1200@60
1080p50	1680x1050@60
1080p60	1920x1200@60RB

**Note:** The 1080i@50 and 1080i@60 output resolutions are supported in 'Matrix' mode only. When these output resolutions are used, Input Port 4 will not function and will not be selectable in the OSD Menu. In 'Dual' or 'TV Wall' modes these output resolutions are unavailable and can not be selected in the OSD menu.



**CYPRESS TECHNOLOGY CO., LTD**  
Home page: <http://www.cypress.com.tw>

MPM-CDPS44SM